

ECO  WAY

NOUVEAU CONCEPT

Kap's  
Way



# Pourquoi vendre de l'eau et du plastique ?

---

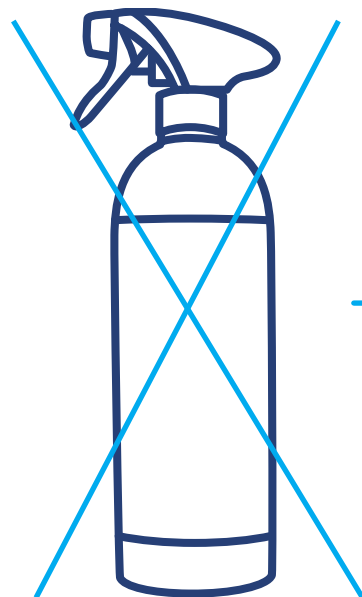

**Kap's  
Way**

Retirons le superflu !



Comment atteindre  
l'objectif ?

# Kap's Way

NOUVEAU CONCEPT



Écologique



Sécuritaire



Économique





Écologique

Réduction de 90% du poids de l'emballage. Pourquoi ?

Bouteille Pulvé  
30g vide

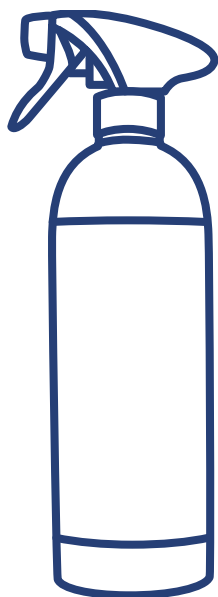

Kap's  
Way

1 KAP'SWAY (10g)  
réutilisable 10 fois

+

1 bouteille pulvé (30g)  
réutilisable 15 fois



On obtient un rapport de 1 sur 10

L'utilisation d'une KAP'SWAY revient à utiliser 10 fois moins de plastique qu'un pulvé prêt à l'emploi (780ml)





Écologique

Réduction de l'empreinte Carbonne = avantage pour le stockage et donc le transport des produits. **Comment ?**

Bouteille Pulvé (pleine)



1600 cm<sup>3</sup>

Kap's  
Way



60 cm<sup>3</sup>



Réduction de **96%** du volume/  
Réduction de **98%** en poids





Sécuritaire

Suppression du contact avec le produit

1.



Verser l'eau  
(étape non dangereuse)

2.



Insérer la capsule  
(étape non dangereuse)

3.

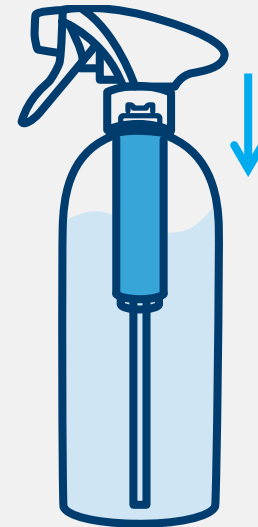

Mettre le pulvé  
(étape non dangereuse)

4.

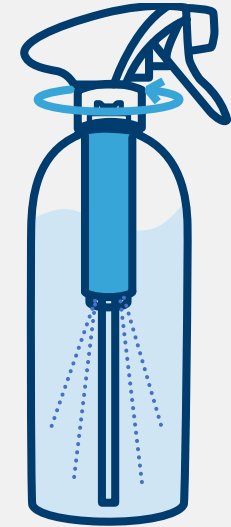

Visser le pulvé pour libérer le  
produit  
(étape non dangereuse)



Avantages :

1. 0 contact avec le produit concentré
2. Utilisation du produit inchangée





Sécuritaire

## Un concept super sécuritaire

Par exemple, si l'agent d'entretien utilise **3 produits** sur un chantier :

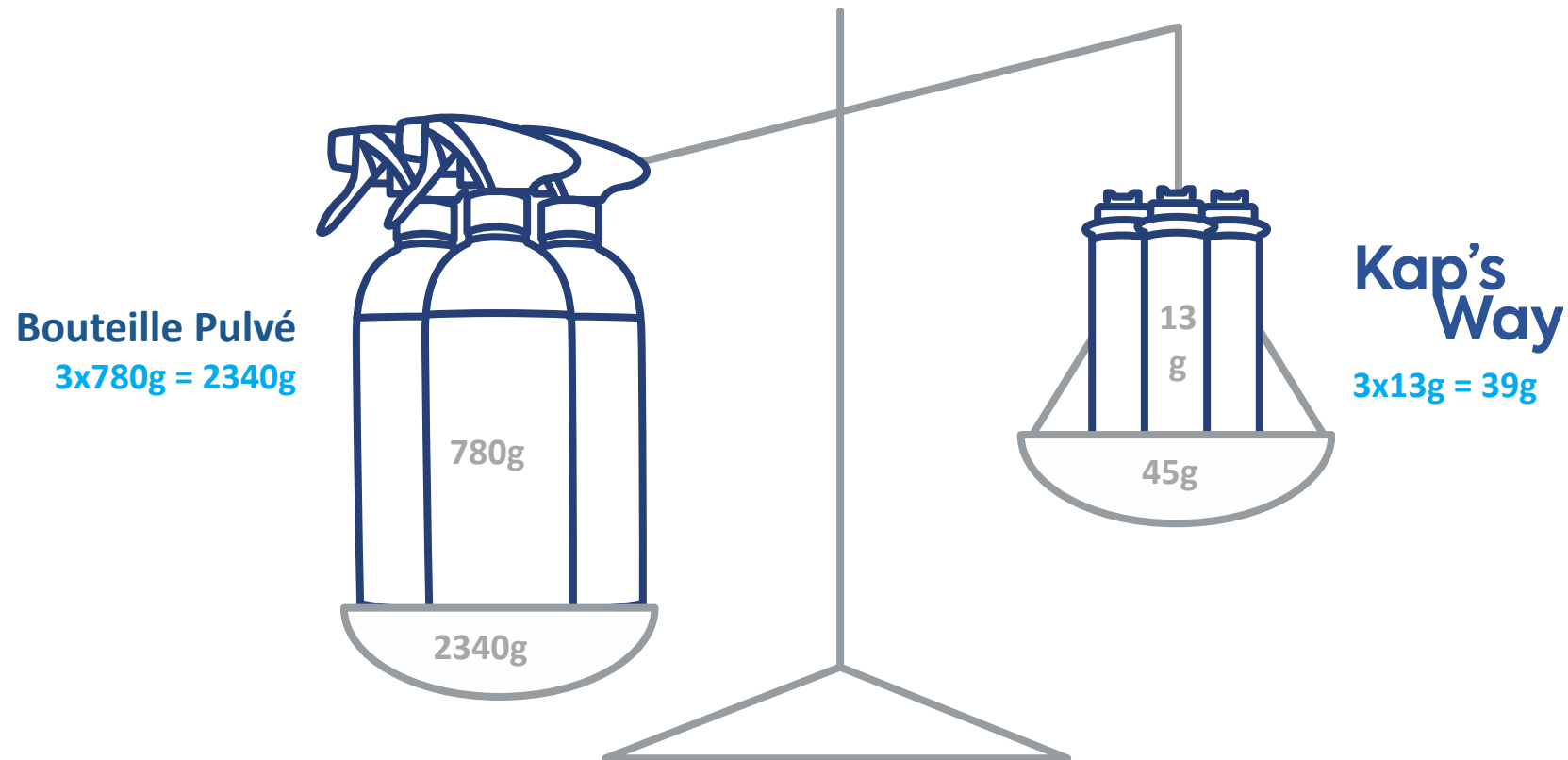

✓ **Diminution poids de 98% et sécuritaire**  
pour l'agent d'entretien qui évite les maux de dos et les TMS





Économique

## Rentabilité du produit

Par exemple, pour les produits vitres, très concurrencé

### Mécanisme du prix

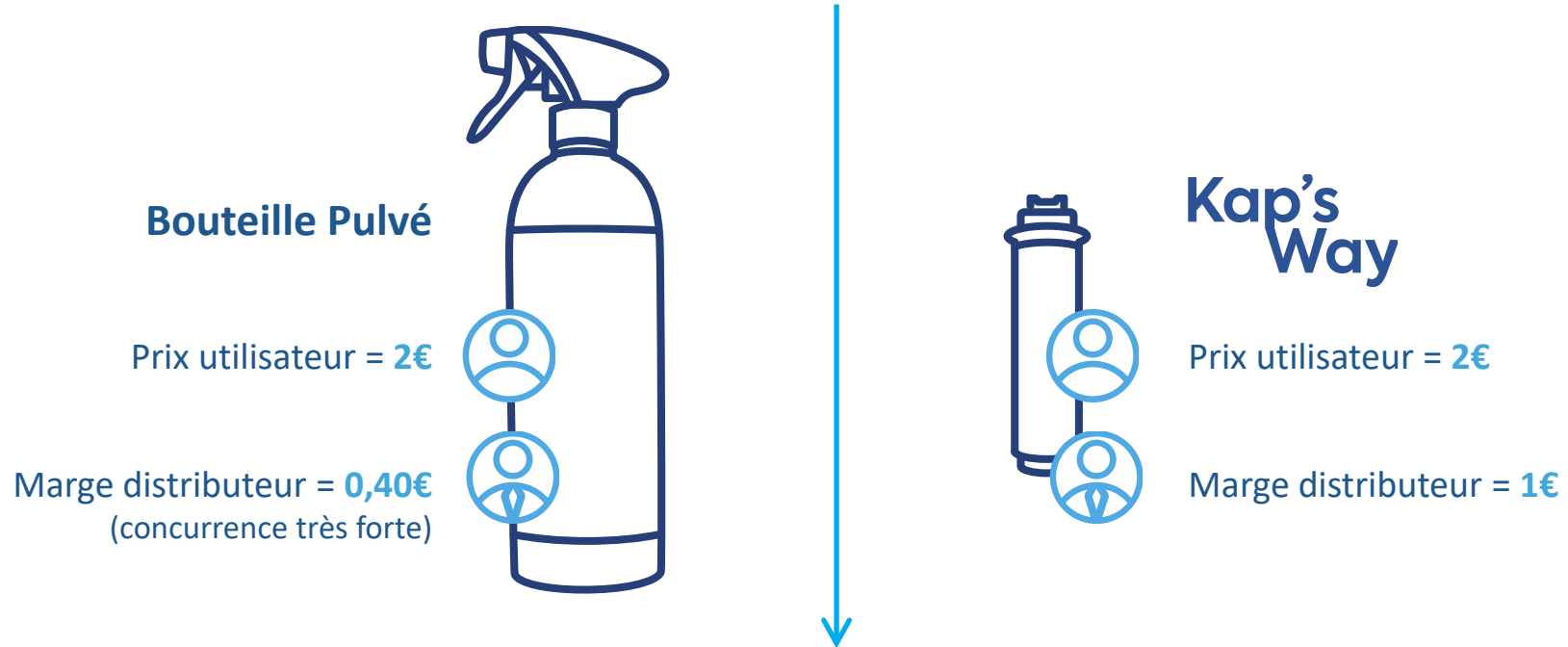

✓ Augmentez vos marges avec l'utilisation des **KAP'SWAY**





## Les produits possibles pour fin 2022

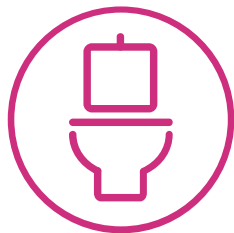

Sanitaire



Vitres

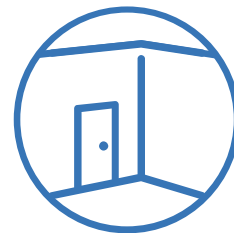

Multi-usages

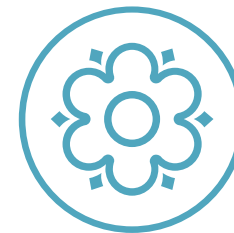

Neutraliseur  
d'odeur

✓ **KAP'SWAY** : une gamme courte et rationalisée



# Service de Consigne (en cours de construction)

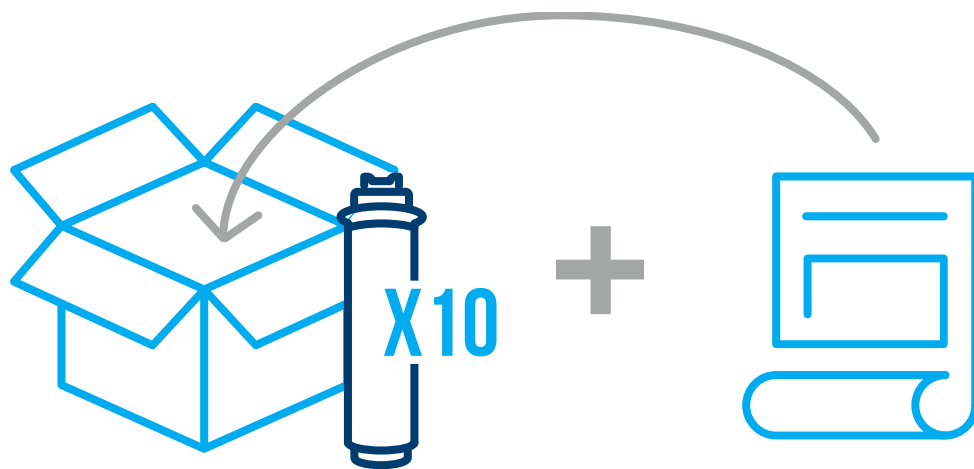

Carton avec **10 KAP'SWAY**

Affranchissement de retour  
vendu par **HTSBIO**

Re-remplissage effectué  
par **HTSBIO**



# En bref



## Écologique

- Réduction de 90% du plastique utilisé
- Réduction de 96% du bilan Carbone
- Certifié Ecocert



## Sécuritaire

- 0 contact avec le produit
- Réduction de 98% du poids manipulé



## Économique

- Des marges multipliées par 2,5
- Pas d'investissement dans des systèmes de dilution



Grâce au concept **KAP'SWAY**, nous passons donc d'un « Dilemme » à une « Vache à lait »





**ALORS KAP'S OU PAS KAP'S ?**

